

REGULATOR

SMT-01 v. 3 | SMT-02 v. 3 | SMT-02H v. 3 | SMT-03 v. 3

USER MANUAL

1. DESCRIPTION.

Temperature regulators of SMT series are a microprocessor-based, programmable temperature controllers, intended for use i.a. in milk coolers and all types of dryers. The series includes the following regulators:

- SMT-01,
- SMT-02,
- SMT-02H,
- SMT-03.

Individual types differ from each other in the way of output of control inputs and outputs. The casing of regulators in this series are adapted for panel mounting.

2. TECHNICAL DATA.

temperature measuring range	between -40 °C and +120 °C
control temperature range	between -40 °C and +120 °C (decreased by a set hysteresis)
measuring resolution of the temperature measurer (resolution of control temperature settings)	1 °C for the range below -9,9 °C 0,2 °C for the range from -10 °C to +100 °C 1 °C for the range over +100 °C
control hysteresis [programmable parameter]	between 0,2 °C and 10 °C for the range from -10 °C to +100 °C between 1 °C and 10 °C for the range <-10 °C and >+100 °C
working time of the stirrer (ventilator) [programmable parameter]	between 1 min. and 60 min.
standstill time of the stirrer (ventilator) [programmable parameter]	between 1 min. and 60 min.
temporary work time of the stirrer (ventilator) [programmable parameter]	between 1 min. and 60 min.
time delay for switching the unit / stirrer on after the regulator is	between 1 s. and 999 s.

turned on or the power supply decay occurs	
length of control sensors	5 m
type of temperature sensor	thermistor NTC
type of temperature measurer	digital LED
load capacity of relay contacts controlling the unit (heating system)	30 A 250 V AC
load capacity of relay contacts controlling the stirrer (ventilator)	10 A 250 V AC
power supply	230 V AC 50 HZ
protection class	IP 55
safety class	CE

3. CONSTRUCTION.

Regulator SMT is placed in a compact casing, including all control and executive elements:

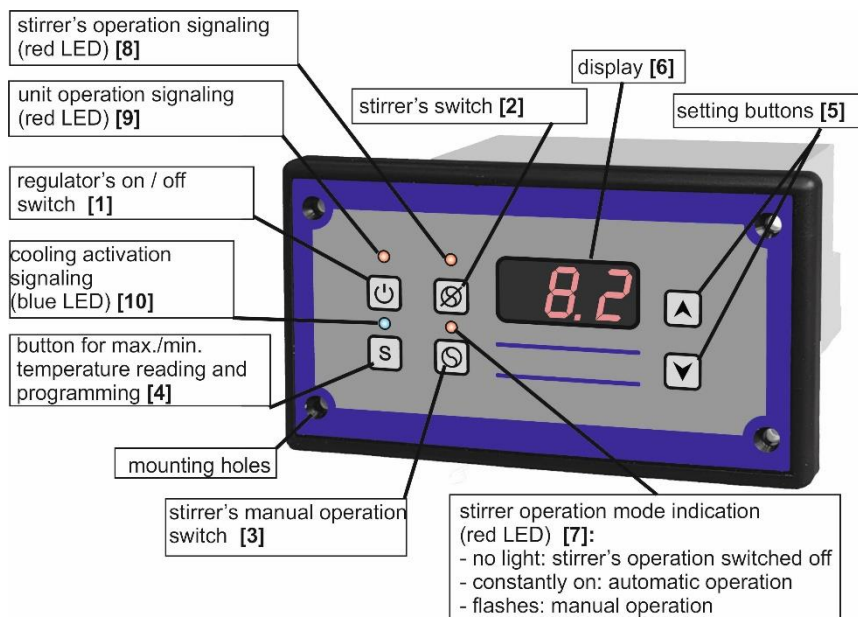

The regulator is equipped with:

- ✓ button for switching the regulator on and off [1],
- ✓ button disabling automatic stirrer (fan) operation [2],
- ✓ button enabling manual operation of the stirrer (fan) [3],
- ✓ digital temperature meter allowing for current temperature control, independently from switching on or off the regulator [6],

- ✓ LEDs signaling the current operating status of the cooling (heating) unit and the stirrer (fan) [7] [8] [9] [10]
- ✓ input for connecting the limit switch,
- ✓ control outputs, that is:
 - unit control output (heating system),
 - stirrer (fan) control output.

SMT-01
outputting of inputs and outputs
using separable connectors



SMT-02
output of the temperature sensor and power
& control cable permanently connected
output of the limit switch input using a
separable connector



SMT-02/H (splashproof version)
output of the temperature sensor and power
& control cable permanently connected
no limit switch input



SMT-03
outputting inputs and outputs using
screwed connections



In the figure above, the types of outputs and inputs are shown, depending on the type of regulator.

The regulator SMT-02H v. 3, apart from cable entry through glands, has a sealing connection of the front part of the casing with its back, which ensures splash-proofness.

ATTENTION

The blue LED indicates the activation of the cooling (heating) mode. If the LED is off, and the regulator is connected to the mains, it means the cooling (heating) operation of the regulator is switched off. However, you can switch on the stirrer's manual operation by pressing the button [3].

If the regulator's control operation is switched off, a dot is displayed on the regulator's display (factory settings). By changing the parameter **d1** (see 6. PROGRAMMING) from the value 0 for value 1, when the regulator is switched off, the display will show the current measured temperature.

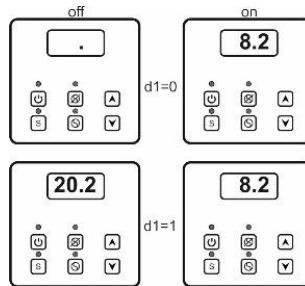

4. SCHEME OF CONNECTION OF THE REGULATOR.

In order to connect the regulator to the device with which it is to be controlled, the following should be done:

- ✓ prepare the hole in the refrigeration device to install the regulator

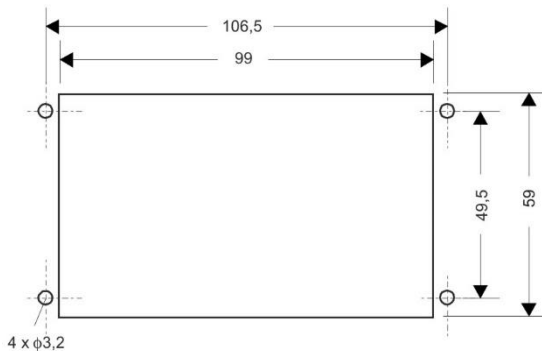

- ✓ place the regulator in the prepared hole and screw it in properly,
- ✓ place the temperature sensor inside the cooling chamber in the most convenient place for temperature measurement and at the same time shielded from accidental damage,
- ✓ connect the regulator to the outputs located on the rear wall of the casing, according to the following scheme:

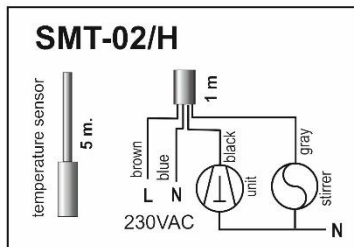
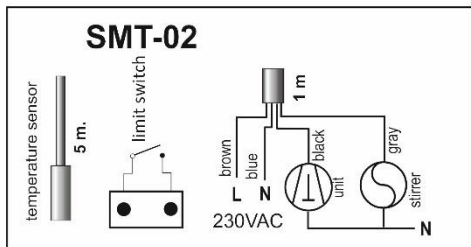
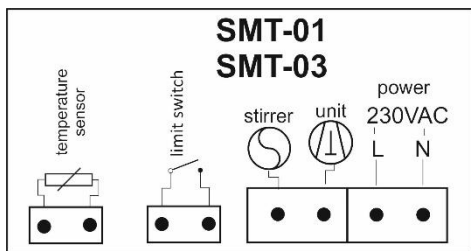

5. REGULATOR FUNCTIONS.

The regulator is equipped with a number of functions that, together with the possibility of creating your own program, enable adjusting the regulator's work to the individual needs of the user. Some of the functions listed below are activated after the appropriate programming of the regulator (see 6. PROGRAMMING and 9. SETTING TABLE).

1. Continuous temperature measurement function, regardless of whether the regulator is on (regulator must be connected to the power supply) – parameter **d1** is set to 1.
2. The function of controlling the refrigeration system (unit), depending on the measured temperature – parameter **C9** is set to the value 0.
3. Light signaling function for switching on the cooling (heating) operation – blue LED is on.
4. Control function of the heating system, depending on the measured temperature – parameter **C9** is set to 1.
5. The stirrer or fan control function enabling the implementation of the following variants of this control – depending on the **F0** parameter settings:
 - a. automatic operation:
 - cyclic operation of the stirrer (fan), independent of the operating condition of the unit (heating system),
 - stirrer operates continuously during the operation of the unit, when the unit is switched off, the stirrer goes into cyclic operation,
 - stirrer (fan) works only when the unit (heating system) is switched on,
 - continuous stirrer (fan) operation while the regulator's operation is on (main application in dryers),

- switched off stirrer (fan) operation,
- b. operation triggered manually:
 - switching on continuous stirrer (fan) operation, regardless of whether the control operation of the regulator is switched on; in order to end the stirrer (fan) operation, press the button **[3]**,
 - switching on the stirrer (fan) operation for a strictly defined time, regardless of whether the control work of the regulator is switched on.
 6. Blocking function of the stirrer and the unit when the flap of the milk cooler tank opens (actuation of the limit switch) – parameter **AF**. In dryers it can be used to turn off the fan, e.g. when the door is opened.
 7. Defining the operation of the limit switch as negative or positive – parameter **UU**.
 8. The unit operation supervision function, consisting in the possibility of setting the maximum and minimum working time of the unit, as well as the minimum standstill time of the unit – parameters **E1** and **E2**.
 9. The function of registering the maximum and minimum temperature values throughout the regulator's working cycle. This function is connected with the possibility of temporally delaying the recording of temperature data to the regulator's memory since its activation – parameter **AA**.
 10. The function of alarm signaling (visual and audible) of exceeding the set temperature range – parameters **HA** and **HE**. This function is connected with the possibility of delaying the time of switching on the alarm system of the regulator from the moment of its activation.
 11. Monitoring and signaling function of the damage to the temperature sensor – in such case the letters ACU appear on the display.
 12. Function of adjustable delay time for switching on the unit and stirrer after decay and re-switching on the voltage – parameter **dE**.

6. PROGRAMMING.

In order to ensure the correct working cycle of the regulator, it is necessary to program its operating parameters accordingly. By default, the controller is programmed for standard operating conditions for the purpose of controlling the milk cooler.

In order to change the factory setting, enter the setting mode. This is done by holding the button marked with the letter S for approx. 17 seconds. After entering the setting mode **UCO** appears on the display. The next pressing of the S button confirms the willingness to make changes. Then press the ▲ key to enter the access code and confirm with the S button. After correct entry into the setting mode, the ▲ and ▼ buttons are used to select the desired parameter. The entry to the parameter settings is made by pressing the S button. The change of the parameter value is made using the ▲ and ▼ buttons; for the change to be saved, confirm with the button S. The exit from

the setting mode is made by setting the **EE** parameter and confirmation with the **S** button or automatically after 17 seconds of inactivity. The following figure illustrates the programming procedure:

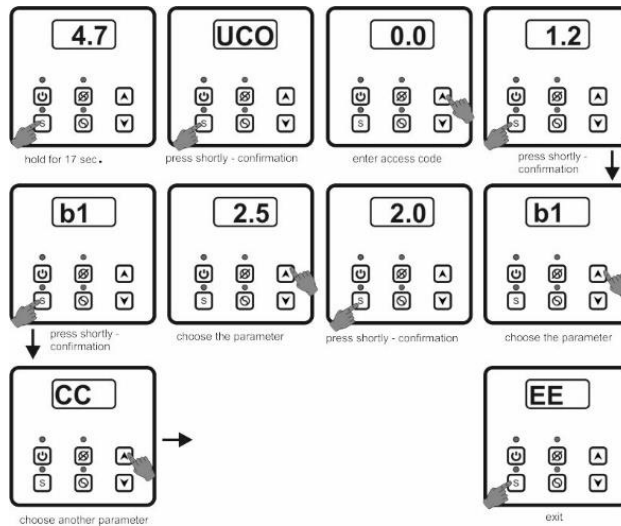

7. THE REGULATOR'S WORK CYCLE.

When the regulator is connected to the mains and its operation is switched on with the button **[1]**, the regulator – after the delay set in parameter **dE** – goes to the control phase.

The regulator controls two control circuits:

- control circuit for the refrigeration (heating) unit;
- control circuit for the stirrer's (fan's) motoreducer.

The work for the control settings of the refrigeration system will be discussed below.

ATTENTION

Parameter **dE** is the delay of switching on the unit and the stirrer after switching on the regulator's work or after the supply voltage decay – default value is set to **5 sec.**

7.1. Control of the refrigeration unit.

The temperature control value (within the range specified in parameters **b1** and **b2**) is set by pressing the buttons marked with the symbols **▲** and **▼**, while short pressing any of these buttons displays the currently set value, while only the next pressing causes the change of this value. Transition on the display from reading the measured temperature to the reading of the set control temperature is signaled by the flashing of digits / numbers.

The unit control in the cooling phase takes place depending on the temperature present in the refrigeration chamber. The regulator can control the cooling temperature in the range of -40 °C up to +120 °C. In order to limit the scope of the control so as to prevent the user of the cooling device from setting the temperature outside this range, set the proper parameters: **b1** (limitation of the lower control temperature range) and **b2** (limitation of the upper control temperature range).

ATTENTION

*Temperatures specified in parameters **b1** and **b2** do not indicate control points for switching off and switching on the operation of the unit.*

*Setting **b1** = **b2** blocks the possibility of changing the programmed temperature by means of the ▲ and ▼ buttons. It is not allowed to set **b1** > **b2**.*

*The change in the value of **b1** or **b2** can be blocked by the currently set control temperature.*

*In the event of such a situation, change the control temperature settings and then change parameters **b1** and / or **b2**.*

It is also important to set the control hysteresis correctly – parameter **HI**. The control hysteresis is a parameter that determines the temperature difference at which the switching off occurs and then the unit is switched on. For example, if the control temperature is set to + 4 °C and hysteresis to 2 °C, then the unit will be switched off after reaching 4 °C, while its re-activation will occur after the temperature has risen to 4+2 = 6 °C.

The regulator allows to set the hysteresis of the control in the range of 0.2 °C to 10 °C, every 0.2 °C.

ATTENTION

If the regulator is set in heating mode, the hysteresis operation has the opposite character, i.e. the heating system is switched off after the temperature has dropped below the set value, taking into account the value of the programmed hysteresis.

7.2. Control of the stirrer's motoreducer.

The working status of the stirrer is signaled by two red LED (see 3. *CONSTRUCTION*):

- signaling of switching on the stirrer's motoreducer [8],
- indication of the stirrer operation mode [7].

The regulator has two modes of stirrer operation, i.e. automatic or manual, which are described in detail below.

7.2.1. Automatic stirrer operation.

In this mode, depending on the settings of parameters **F0**, **E1** and **E2**, the stirrer may be connected to the operation of the unit or completely independent of the operation of the unit (see 9. *TABLE OF SETTINGS*).

The stirrer operation setting in the automatic mode is signaled by the continuous lighting of the red LED [7].

The stirrer's operation can be switched off at any time by means of the **[2]** button (see 3. *CONSTRUCTION*), except when the **F0** parameter is set to 2 or 3. Switching off the regulator by pressing the **[1]** button also turns off the stirrer operation.

7.2.2. Manually triggered stirrer operation.

The manual stirrer operation can be initiated by pressing the button marked by symbol  **[3]** (see 3. *CONSTRUCTION*); at this point, the automatic operation of the stirrer stops and the manual operation starts. Manual operation of the stirrer is also possible when the regulator is switched off (button **[1]**) or stirrer operation switched off (button **[2]**). The manual operation of the stirrer is not interrupted when the regulator is switched off manually by pressing the **[1]** button.

The setting of the stirrer operation in manual mode is signaled by a flashing red LED **[7]**. The stirrer operation in this mode can be interrupted at any time by pressing the button  again. The manual stirrer operation can take place in two variants, depending on the **CP** parameter settings:

- setting the value 0 means continuous stirrer operation,
- setting the value >0 means that the stirrer works for the set number of minutes; after the set time elapses, the manual operation of the stirrer is switched off.

ATTENTION

*No light signaling of the stirrer operation **[7]** **[8]** when the regulator is switched off means that the automatic stirrer operation has been switched off, at the same time the manual operation has not been switched on.*

8. ADDITIONAL FUNCTIONS.

Below, some specific functions of the regulator will be described, enabling the regulator to be used for various applications.

8.1. Limit switch of the flap.

The regulator is equipped with the possibility of connecting the external limit switch of the tank flap. The principle of operation of this input consists in immediately switching off the stirrer's operation at the moment of shorting or opening of this input (depending on the **UU** parameter setting), made by the connected limit switch of the flap. The return of the stirrer operation (after being interrupted by the limit switch) follows after the disappearance of the flap opening signal with a delay of 5 seconds.

At the same time, depending on the **AF** parameter settings made, it is possible to disable the unit operation. The unit operation is switched off with a set delay in relation to the opening signal of the flap, so that the momentary opening does not immediately stop the operation of the unit. The unit returns to work after the flap opening signal disappears, taking into account the programmed minimum standstill time of the unit.

8.2. The function of registering the minimum and maximum temperatures.

The SMT regulator has the function of recording in its internal memory the values of maximum and minimum temperatures that occur throughout the regulator's operating cycle. This function makes it possible to check whether the milk is stored under the correct temperature conditions.

When the device is switched on, after the end of the programmed delay (parameter **AA** – see 9. *TABLE OF SETTINGS*), the temperature values are recorded to the regulator's memory. The programmable delay time of enabling this function allows for pre-cooling of the milk after the start of cooling and thus not taking into account the maximum temperature when the device is started. This time should be selected by the user for the type of tank and the actual operating conditions of the device.

At any time, the user can read the maximum and minimum temperature values presently available. The following figure illustrates reading:

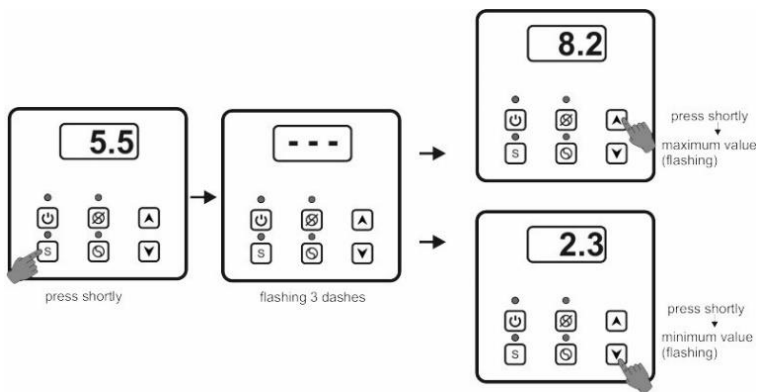

ATTENTION

1. In the absence of entries of maximum and minimum temperatures in the regulator's memory, the symbol --- is displayed.
2. Power supply loss causes the regulator's memory to be cleared.

At any time, you can manually delete the current maximum and minimum values. The following figure illustrates manual memory erasing:

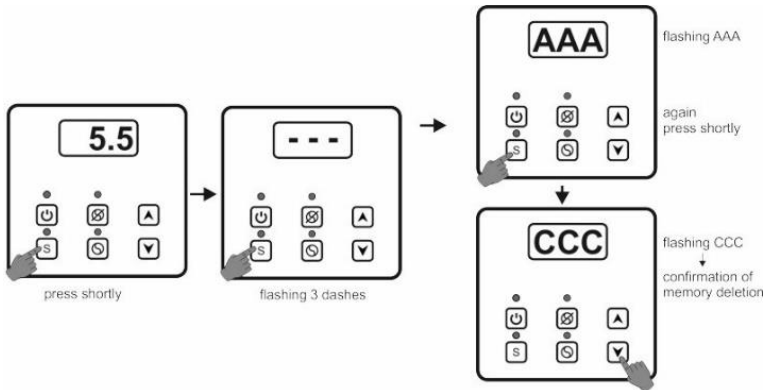

8.3. The function of alarm signaling the exceeding of the correct temperature range.

The regulator has the function of signaling the exceeding of the set temperature range. In order for the function to work properly, the appropriate temperature range must first be programmed, this is: parameter **A1** – temperature below which the alarm will be activated and parameter **A2** – temperature above which the alarm will be triggered (see 9. TABLE OF SETTINGS).

The third parameter to be defined is the time delay of switching on the alarm function from the moment the regulator’s operation is switched on – parameter **AA**. This delay eliminates the triggering of an alarm in the initial cooling phase.

Exceeding the set temperature range is signaled visually and sound. In the event of activation of the alarm, the buzzer is triggered cyclically every 1 minute for 5 seconds, and at the same time letters PPP and the temperature value are displayed.

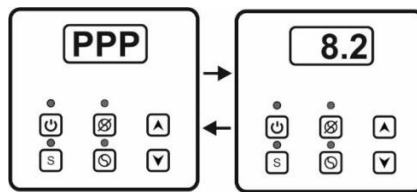

ATTENTION
*The parameter **AA** is identical to the delay specified in the maximum and minimum temperature recording function. In other words, the delay value set in the parameter **AA** will be the same for recording max. and min. temperature and for parameters **A1** and **A2**.*

The audible alarm can be turned off by setting the **HE** parameter to 1 (see 9. TABLE OF SETTINGS). In this case, exceeding the set temperature range is signaled only visually, as shown in the figure above. The alarm system (audible and visual) can also be turned off completely by changing the **HA** parameter to 1 (see 9. TABLE OF SETTINGS).

8.4. Temperature sensor damage indication.

If the regulator detects damage to the temperature sensor, the letters **ACU** appears on the display, and at the same time the audible alarm signal is activated. The operation of the unit and the stirrer is interrupted until the failure is removed.

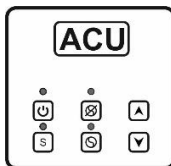

ATTENTION

Sensor damage indication also occurs if the range of temperatures measured by the regulator is exceeded.

9. TABLE OF SETTINGS.

DESCRIPTION OF THE PARAMETER	SYMBOL	SETTING RANGE	FACTORY SETTING
accessing the settings	UC0	access code	1.2
regulator operation mode	C9	0 – cooling 1 – heating	0
limitation of the lower value for the control temperature range	b1	the possibility of setting the temperature from -40 °C to +120 °C, every 1.0 °C	2 (°C)
limitation of the upper value for the control temperature range	b2	the possibility of setting the temperature from -40 °C to +120 °C, every 1.0 °C	10 (°C)
control hysteresis	HI	the possibility of setting the temperature: <ul style="list-style-type: none"> from 0.2 °C to 10 °C, every 0.2 °C – for the range from -10 °C to +100 °C and from 1.0 °C to 10 °C, every 1.0 °C – for the range of <-10 °C and > + 100 °C 	2 (°C)
minimum working time of the unit	CA	0 – off 1 – on: the possibility of setting the time from 1 min. to 60 min., every 1 min.	0
maximum working time of the unit	CC	0 – off 1 – on: the possibility of setting the time from 0,5 h to 9,5 h, every 0,5 h	0
minimum standstill time of the unit (standby)	CF	0 – off 1 – on: the possibility of setting the time from 1 min. to 60 min., every 1 min.	0
time after which the unit is turned off after the flap of the milk tank is opened	AF	0 – off 1 – on: the possibility of setting the time from 0,1 min. (6 s.) to 15 min., every 0,1 min. (6 s.)	0,1 (min.) [= 6 s.]
stirrer operation mode	FO	0 – operation according to the times set in the parameters E1 and E2, regardless of the operation of the unit 1 – continuous operation while the unit is running; when the unit is on standby, the stirrer operates according to the times set in the	1

		parameters E1 and E2 2 – as in setting 1, but disabling with the stirrer's working button causes its operation only during the operation of the unit 3 – as in setting 1, but the button that disables the stirrer operation is inactive 4 – continuous operation, regardless of the operation of the unit and times set in the parameters E1 and E2	
standstill time of the stirrer	E1	the possibility of setting the time from 1 min. to 60 min., every 1 min.	15 (min.)
working time of the stirrer	E2	the possibility of setting the time from 1 min. to 60 min., every 1 min.	2 (min.)
manual stirrer operation mode	CP	0 – continuous work >0 – stirrer operation for a specified time in the range of from 1 min. to 60 min., every 1 minute	5 (min.)
delay of registering of the max. / min. values of temperature and delay of activation of the temperature alarm	AA	the possibility of setting the time from 0 h to 24 h, every 0,1 h	2 (h)
lower temperature of the alarm	A1	the possibility of setting the temperature from -40 °C to +120 °C, every 1.0 °C	2 (°C)
upper temperature of the alarm	A2	the possibility of setting the temperature from -40 °C to +120 °C, every 1.0 °C	12 (°C)
sound of the alarm	HE	0 – on 1 – off	0
visual and sound alarm of exceeding the set temperature range (parameters A1 and A2)	HA	0 – on 1 – off	0
scaling the control sensor**	CU	every 0,2 °C	scalable value
setting the operation of the limit switch of opening the tank's flap	UU	0 – closing the limit switch: raising the flap 1 – opening the limit switch: raising the flap	0
delay of switching on the unit and the stirrer after connecting the regulator to the mains or when power supply decay occurs	dE	from 1 s. to 999 s., every 1 s.	5 (s.)
display status when the control is switched off	d1	0 – the dot is displayed 1 – the currently measured temperature is displayed	0
return to factory settings	FA	0 1 – after setting "1" and turning off the regulator from the power supply, switching on again restores the factory settings and the parameter value goes back to "0"	0
leaving the settings	EE		

** set at the manufacturing stage (do not change without obvious need)