

REGULATOR SMT-05 v. 3

User manual

1. DESCRIPTION.

Temperature regulator SMT-05 v. 3 is a microprocessor-based, programmable temperature controller, intended for use in comprehensive servicing of milk coolers, beer wort tanks, all types of dryers, chambers and sterilizing and pasteurizing devices, devices for producing juices, heating of swimming pools, or for foil tunnels.

The regulator casing is hermetic (IP 65 protection class) and therefore resistant to humidity, dirt and low temperature; electronics of the regulator is able to work in temperatures up to -10°C . The casing is adapted for wall mounting.

In the set with the regulator there is a temperature sensor in the rubber cover (protection class IP68), ended with a stainless steel sleeve. The regulator signals the failure of the temperature sensor. A number of functions that the regulator is equipped with, as well as the ability for the user to create his own regulator work program, make it a universal controller to manage the operation of the refrigeration unit and the stirrer, or e.g. the heater and fan.

2. TECHNICAL DATA.

temperature measuring range	from -40 °C to +120 °C
control temperature range	from -40 °C to +120 °C (decreased by a set hysteresis)
measuring resolution of the temperature measurer (resolution of control temperature settings)	<ul style="list-style-type: none">• 1 °C – for the range below -9.9 °C and over +100 °C• 0.2 °C – for the range from -10 °C to +100 °C
control hysteresis [programmable parameter]	<ul style="list-style-type: none">• from 0.2 °C to 10 °C – for the range from -10 °C to +100 °C• from 1 °C to 10 °C – for the range <-10 °C and >+100 °C
operation time of the stirrer / ventilator [programmable parameter]	from 1 min. to 60 min.
standstill time of the stirrer / ventilator [programmable parameter]	from 1 min. to 60 min.
temporary operation time of the stirrer / ventilator [programmable parameter]	from 1 min. to 60 min.
time delay for switching the chiller (unit) / stirrer on after the regulator is turned on or the power supply decay occurs	from 1 sec. to 999 sec.
length of control sensors	5 m
type of temperature sensor	thermistor NTC
type of temperature measurer	digital LED
load capacity of relay contacts controlling the chiller (unit) / heating system	30 A 250 V AC
load capacity of relay contacts controlling the stirrer / ventilator	10 A 250 V AC
power supply	230 V AC 50 HZ
protection class	IP 65
safety class	CE

3. CONSTRUCTION.

SMT-05 regulator is placed in a compact, hermetic casing, intended for wall mounting, including all control and executive elements:

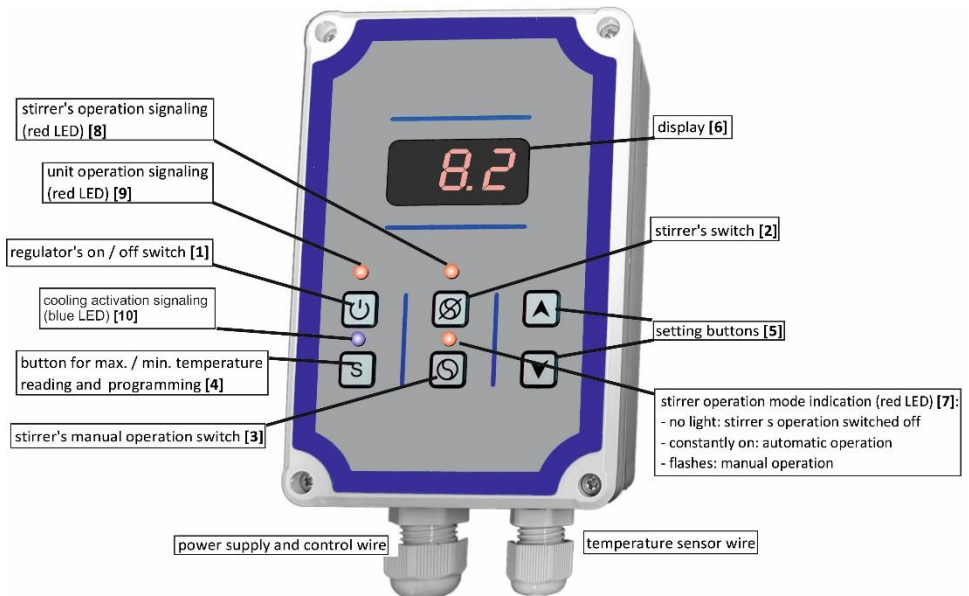

ATTENTION

The blue LED indicates the activation of the cooling / heating mode. If the LED is off, and the regulator is connected to the mains, it means the cooling / heating operation of the regulator is switched off. However, you can switch on the stirrer's manual operation by pressing the button [3].

If the regulator's control operation is switched off, a dot is displayed on the regulator's display (factory settings). By changing the parameter **d1** (see section 6.) from the value 0 to 1, when the regulator is switched off, the display will show the current measured temperature.

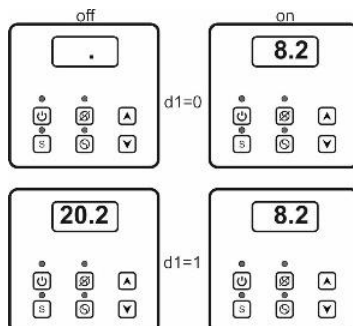

The regulator is equipped with:

- ✓ button for switching the regulator on and off **[1]**,
- ✓ button disabling automatic stirrer / ventilator operation **[2]**,
- ✓ button enabling manual operation of the stirrer / ventilator **[3]**,
- ✓ digital temperature meter allowing for current temperature control, independently from switching on or off the regulator **[6]**,
- ✓ LEDs signaling the current operating status of the cooling / heating unit and the stirrer / ventilator **[7] [8] [9] [10]**
- ✓ input for connecting the limit switch,
- ✓ control outputs, that is:
 - chiller (unit) / heating system control output,
 - stirrer / ventilator control output.

4. SCHEME OF CONNECTION OF THE REGULATOR.

In order to connect the regulator to the device with which it is to be controlled, the following should be done:

- ✓ mount the regulator in its place of work; the fixing of the regulator is carried out in the following way:
 - unscrew the screws of the casing cover,
 - take off the cover,
 - screw the regulator casing to the prepared structure through the fixing holes,
 - put on the cover,
 - fasten the screws of the casing cover,
- ✓ place the temperature sensor inside the cooling chamber in the most convenient place for temperature measurement and at the same time shielded from accidental damage,
- ✓ make the regulator connection according to the following scheme:

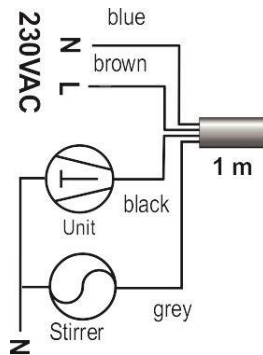

5. REGULATOR FUNCTIONS.

The regulator is equipped with a number of functions that, together with the possibility of creating your own program, enable adjusting the regulator's work to the individual needs of the user. Some of the functions listed below are activated after the appropriate programming of the regulator (see section and section 9.).

1. **Continuous temperature measurement function**, regardless of whether the regulator is on (it must be connected to the power supply) – parameter **d1** is set to 1.
2. **The function of controlling the refrigeration system (chiller)**, depending on the measured temperature – parameter **C9** is set to the value 0.
3. **Light signaling function for switching on the cooling / heating operation** – blue LED is on.
4. **Control function of the heating system**, depending on the measured temperature – parameter **C9** is set to 1.
5. **The stirrer or ventilator control function**, enabling the implementation of the following variants of this control – depending on the **F0** parameter settings:
 - a. automatic operation:
 - cyclic operation of the stirrer / ventilator, independent of the operating condition of the chiller (unit) / heating system,
 - stirrer operates continuously during the operation of the chiller (unit), when the chiller is switched off, the stirrer goes into cyclic operation,
 - stirrer / ventilator operates only when the chiller / heating system is switched on,
 - continuous stirrer / ventilator operation while the regulator's operation is on (main application in dryers),
 - switched off stirrer / ventilator operation,
 - b. operation triggered manually:
 - switching on continuous stirrer / ventilator operation, regardless of whether the control operation of the regulator is switched on; in order to end the stirrer operation, press the button **[3]**,
 - switching on the stirrer / ventilator operation for a strictly defined time, regardless of whether the control work of the regulator is switched on.
6. **Blocking function of the stirrer and the chiller (unit) when the flap of the milk cooler tank opens** (actuation of the limit switch) – parameter **AF**. In dryers it can be used to turn off the ventilator, e.g. when the door is opened.
7. **Defining the operation of the limit switch as negative or positive** – parameter **UU**.
8. **The chiller (unit) operation supervision function**, consisting in the possibility of setting the maximum and minimum operation time of the chiller (unit), as well as its minimum standstill time – parameters **E1** and **E2**.
9. **The function of registering the maximum and minimum temperature values throughout the regulator's working cycle**. This function is connected with the possibility of temporally

delaying the recording of temperature data to the regulator's memory since its activation – parameter **AA**.

10. **The function of alarm signaling (visual and audible) of exceeding the set temperature range** – parameters **HA** and **HE**. This function is connected with the possibility of delaying the time of switching on the alarm system of the regulator from the moment of its activation.
11. **Monitoring and signaling function of the damage to the temperature sensor** – in such case the letters **ACU** appear on the display.
12. **Function of adjustable delay time for switching on the chiller (unit) and stirrer** after decay and re-switching on the voltage – parameter **dE**.

6. PROGRAMMING.

In order to ensure the correct working cycle of the regulator, it is necessary to program its operating parameters accordingly. By default, the controller is programmed for standard operating conditions for the purpose of controlling the milk cooler.

In order to change the factory setting, enter the setting mode. This is done by holding the button marked with the letter **S** for approx. 17 seconds. After entering the setting mode **UCO** appears on the display. The next pressing of the **S** button confirms the willingness to make changes. Then press the **▲** key to enter the access code and confirm with the **S** button. After correct entry into the setting mode, the **▲** and **▼** buttons are used to select the desired parameter. The entry to the parameter settings is made by pressing the **S** button. The change of the parameter value is made using the **▲** and **▼** buttons; for the change to be saved, confirm with the button **S**. The exit from the setting mode is made by setting the **EE** parameter and confirmation with the **S** button or automatically after 17 seconds of inactivity.

The following figure illustrates the programming procedure:

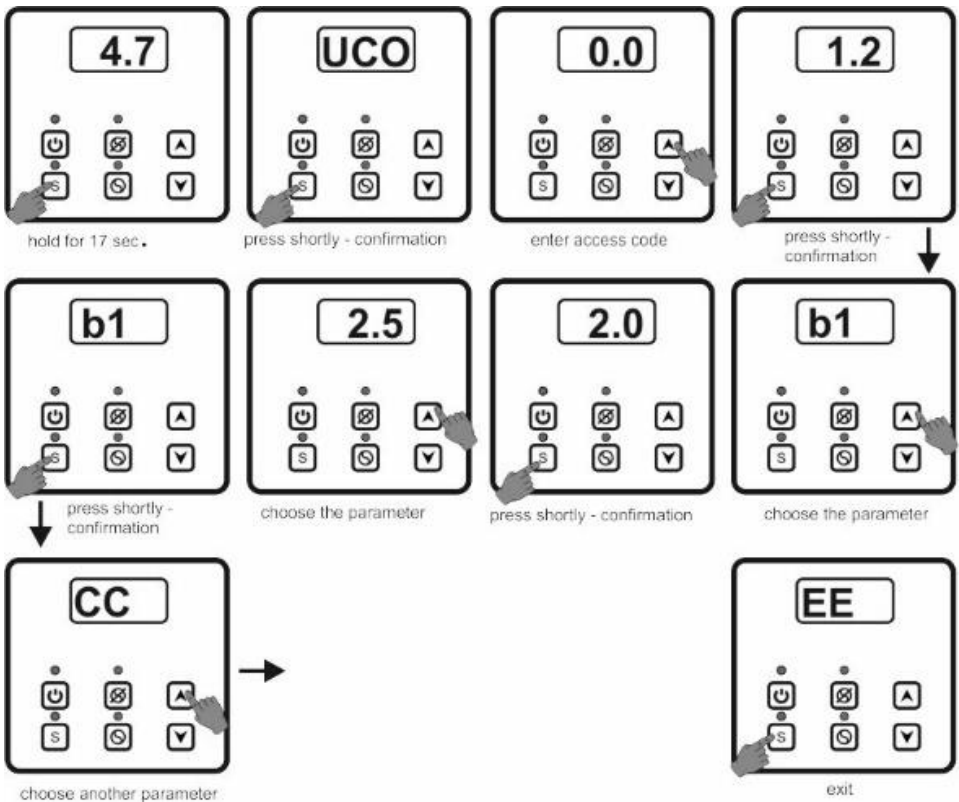

7. THE REGULATOR'S WORK CYCLE.

When the regulator is connected to the mains and its operation is switched on with the button [1], the regulator goes – after the delay set in parameter **dE** – to the control phase.

The regulator controls two control circuits:

- a) control circuit for the refrigeration / heating unit;
- b) control circuit for the stirrer's motoreducer.

The work for the control settings of the refrigeration system will be discussed below.

ATTENTION

Parameter **dE** is the delay of switching on the chiller (unit) and the stirrer after switching on the regulator's work or after the supply voltage decay – default value is set to **5 sec**.

7.1. Control of the refrigeration unit.

The temperature control value (within the range specified in parameters **b1** and **b2**) is set by pressing the buttons marked with the symbols ▲ and ▼, while short pressing any of these buttons displays the currently set value, while only the next pressing causes the change of this value. Transition from reading the measured temperature to the reading of the set control temperature is signaled by the digits / numbers flashing.

The chiller (unit) control in the cooling phase takes place depending on the temperature present in the refrigeration chamber. The regulator can control the cooling temperature in the range of -40 °C up to +120 °C. In order to limit the scope of the control so as to prevent the user of the cooling device from setting the temperature outside this range, set the proper parameters: **b1** (limitation of the lower control temperature range) and **b2** (limitation of the upper control temperature range).

ATTENTION

*Temperatures specified in parameters **b1** and **b2** do not indicate control points for switching off and switching on the operation of the unit.*

*Setting **b1=b2** blocks the possibility of changing the programmed temperature by means of the ▲ and ▼ buttons. It is not allowed to set **b1 > b2**.*

*The change in the value of **b1** or **b2** can be blocked by the currently set control temperature. In the event of such a situation, change the control temperature settings and then change parameters **b1** and / or **b2**.*

It is also important to set the control hysteresis correctly – parameter **HI**. The control hysteresis is a parameter that determines the temperature difference at which the switching off occurs and then the unit is switched on. For example, if the control temperature is set to + 4 °C and hysteresis to 2 °C, then the unit will be switched off after reaching 4 °C, while its re-activation will occur after the temperature has risen to $4+2 = 6$ °C.

The regulator allows to set the hysteresis of the control in the range of 0.2 °C to 10 °C, every 0.2 °C.

ATTENTION

If the regulator is set in heating mode, the hysteresis operation has the opposite character, i.e. the heating system is switched off after the temperature has dropped below the set value, taking into account the value of the programmed hysteresis.

7.2. Control of the stirrer's motoreducer.

The working status of the stirrer is signaled by two red LED (see section 3.):

- signaling of switching on the stirrer's motoreducer [8],
- indication of the stirrer operation mode [7].

The regulator has two modes of stirrer operation, i.e. automatic or manual, which are described in detail below.

7.2.1. Automatic stirrer operation.

In this mode, depending on the settings of parameters **F0**, **E1** and **E2**, the stirrer may be connected to the operation of the unit or completely independent of the operation of the chiller (unit) (see section 9.).

The stirrer operation setting in the automatic mode is signaled by the continuous lighting of the red LED [7].

The stirrer's operation can be switched off at any time by means of the [2] button (see section 3.), except when the **F0** parameter is set to 2 or 3.

Switching off the regulator by pressing the [1] button also turns off the stirrer operation.

7.2.2. Manually triggered stirrer operation.

The manual stirrer operation can be initiated by pressing the button marked by symbol  [3] (see section 3.); at this point, the automatic operation of the stirrer stops and the manual operation starts. Manual operation of the stirrer is also possible when the regulator is switched off (button [1]) or stirrer operation switched off (button [2]). The setting of the stirrer operation in manual mode is signaled by a flashing red LED [7].

The manual operation of the stirrer is not interrupted when the regulator is switched off manually by pressing the [1] button.

The stirrer operation in this mode can be interrupted at any time by pressing the button  again.

The manual stirrer operation can take place in two variants, depending on the **CP** parameter settings:

- setting the value 0 means continuous stirrer operation,
- setting the value >0 means that the stirrer operates for the set number of minutes; after the time set elapses, the manual operation of the stirrer is switched off.

ATTENTION

No light signaling of the stirrer operation [7] [8] when the regulator is switched off means that the automatic stirrer operation has been switched off, at the same time the manual operation has not been switched on.

8. ADDITIONAL FUNCTIONS.

Below, some specific functions of the regulator will be described, enabling the regulator to be used for various applications.

8.1. Limit switch of the flap.

The regulator is equipped with the possibility of connecting the external limit switch of the tank flap. The principle of operation of this input consists in immediately switching off the stirrer's operation at the moment of shorting or opening of this input (depending on the **UU** parameter setting), made by the connected limit switch of the flap. The return of the stirrer operation (after being interrupted by the limit switch) follows after the disappearance of the flap opening signal with a delay of 5 seconds.

At the same time, depending on the **AF** parameter settings made, it is possible to disable the chiller (unit) operation. The chiller operation is switched off with a set delay in relation to the opening signal of the flap, so that the momentary opening does not immediately stop the operation of the chiller. The chiller restarts operation after the flap opening signal disappears, taking into account the programmed minimum standstill time of the chiller.

8.2. The function of registering the minimum and maximum temperatures.

The SMT-05 regulator has the function of recording in its internal memory the values of maximum and minimum temperatures that occur throughout the regulator's operating cycle. This function makes it possible to check whether the milk is stored under the correct temperature conditions.

When the device is switched on, after the end of the programmed delay (parameter **AA** – see section 9.), the temperature values are recorded to the regulator's memory. The programmable delay time of enabling this function allows pre-cooling of the milk after the start of cooling and thus not taking into account the maximum temperature when the device is started. This time should be selected by the user for the type of tank and the actual operating conditions of the device.

At any time, the user can read the maximum and minimum temperature values presently available. The following figure illustrates reading:

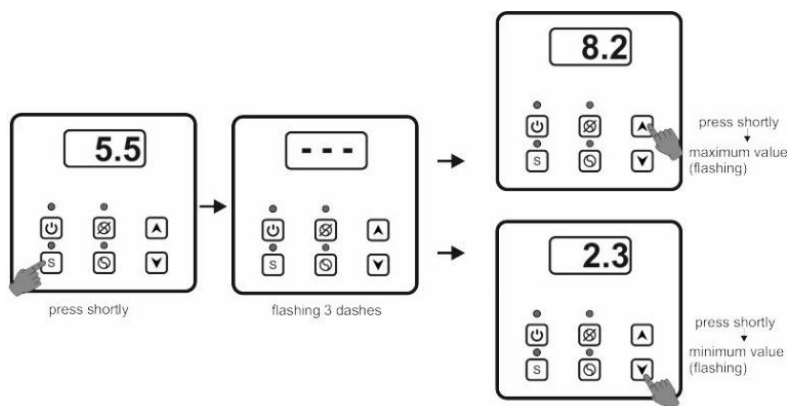

ATTENTION

1. In the absence of entries of maximum and minimum temperatures in the regulator's memory, the symbol --- is displayed.
2. Power supply loss causes the regulator's memory to be cleared.

At any time, you can manually delete the current maximum and minimum values. The following figure illustrates manual memory erasing:

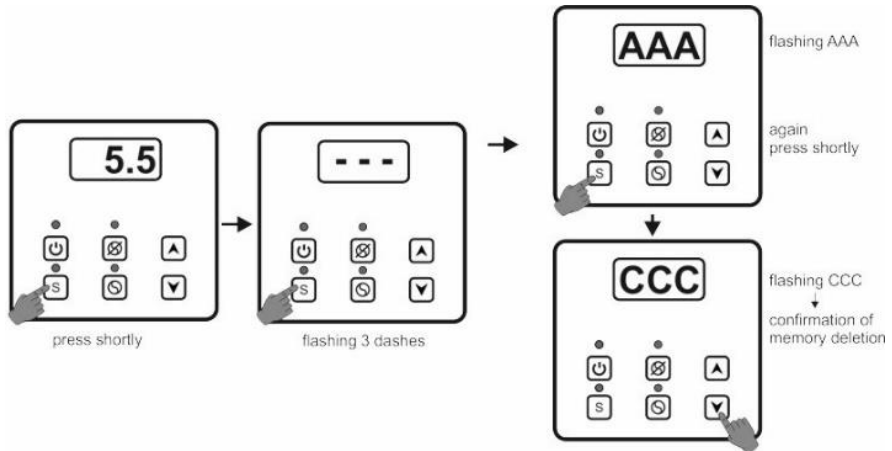

8.3. The function of alarm signaling the exceeding of the correct temperature range.

The regulator has the function of signaling the exceeding of the set temperature range. In order for the function to work properly, the appropriate temperature range must first be programmed, this is: parameter **A1** – temperature below which the alarm will be activated and parameter **A2** – temperature above which the alarm will be triggered (see section 9.).

The third parameter to be defined is the time delay of switching on the alarm function from the moment the regulator's operation is switched on – parameter **AA**. This delay eliminates triggering of an alarm in the initial cooling phase.

Exceeding the set temperature range is signaled visually and sound. In the event of activation of the alarm, the buzzer is triggered cyclically every 1 minute for 5 seconds, and at the same time letters **PPP** and the temperature value are displayed.

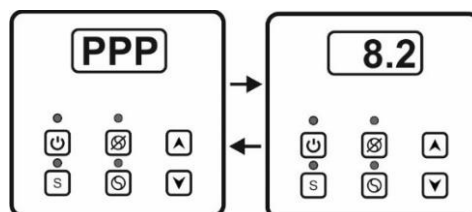

ATTENTION

The parameter **AA** is identical to the delay specified in the maximum and minimum temperature recording function.

In other words, the delay value set in the parameter **AA** will be the same for recording maximum and minimum temperature and for parameters **A1** and **A2**.

The audible alarm can be turned off by setting the **HE** parameter to 1 (see section 9.). In this case, exceeding the set temperature range is signaled only visually, as shown in the figure above. The alarm system (audible and visual) can also be turned off completely by changing the **HA** parameter to 1 (see section 9.).

8.4. Temperature sensor damage indication.

If the regulator detects damage to the temperature sensor, the letters **ACU** appears on the display, and at the same time the audible alarm signal is activated. The operation of the chiller (unit) and the stirrer is interrupted until the failure is removed.

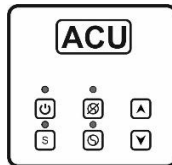

ATTENTION

Sensor damage indication also occurs if the range of temperatures measured by the regulator is exceeded.

9. TABLE OF SETTINGS.

DESCRIPTION OF THE PARAMETER	SYMBOL	SETTING RANGE	FACTORY SETTING
accessing the settings	UC0	access code	1.2
regulator operation mode	C9	0 – cooling 1 – heating	0
limitation of the lower value for the control temperature range	b1	setting the temperature from -40 °C to +120 °C, every 1.0 °C	2 (°C)
limitation of the upper value for the control temperature range	b2	setting the temperature from -40 °C to +120 °C, every 1.0 °C	10 (°C)
control hysteresis	HI	setting the temperature: <ul style="list-style-type: none"> from 0.2 °C to 10 °C, every 0.2 °C – for the range from -10 °C to +100 °C from 1.0 °C to 10 °C, every 1.0 °C – for the range of <-10 °C and > + 100 °C 	2 (°C)
minimum operation time of the chiller (unit)	CA	0.00 – inactive >0.00 – active: setting the time from 1 min. to 60 min., every 1 min.	0
maximum operation time of the chiller (unit)	CC	0.00 – inactive >0.00 – active: setting the time from 0,5 h to 9,5 h, every 0,5 h	0
minimum standstill time of the chiller (unit)	CF	0.00 – inactive >0.00 – active: setting the time from 1 min. to 60 min., every 1 min.	0
time after which the chiller (unit) is turned off after the flap of the milk tank is opened	AF	0.00 – inactive >0.00 – active: setting the time from 0,1 min. (6 sec.) to 15 min., every 0,1 min. (6 sec.)	0.1 (min.) [= 6 sec.]
stirrer operation mode	F0	0 – operation according to the times set in E1 and E2 , regardless of the operation of the chiller (unit) 1 – continuous operation while the chiller (unit) is running; when the chiller is on standby, the stirrer operates according to the times set in E1 and E2 2 – as in setting 1, but disabling with the stirrer's operation button causes its operation only during the operation of the chiller 3 – as in setting 1, but the button that disables the stirrer operation is inactive 4 – continuous operation, regardless of the operation of the chiller (unit) and times set in E1 and E2	1
standstill time of the stirrer	E1	setting the time from 1 min. to 60 min., every 1 min.	15 (min.)
operation time of the stirrer	E2	setting the time from 1 min. to 60 min., every 1 min.	2 (min.)

manual stirrer operation mode	CP	0.0 – continuous work >0.0 – stirrer operation for a specified time in the range of from 1 min. to 60 min., every 1 min.	5 (min.)
delay of registering of the maximum / minimum values of temperature and delay of activation of the temperature alarm	AA	setting the time from 0 h to 4 h, every 0,1 h	2 (h)
lower temperature of the alarm	A1	setting the temperature from -40 °C to +120 °C, every 1.0 °C	2 (°C)
upper temperature of the alarm	A2	setting the temperature from -40 °C to +120 °C, every 1.0 °C	12 (°C)
sound of the alarm	HE	0 – active 1 – inactive	0
visual and sound alarm of exceeding the set temperature range (parameters A1 and A2)	HA	0 – active 1 – inactive	0
scaling the control sensor**	CU	every 0,2 °C	scalable value
setting the operation of the limit switch of opening the tank's flap	UU	0 – closing the limit switch: raising the flap 1 – opening the limit switch: raising the flap	0
delay of switching on the chiller (unit) and the stirrer after connecting the regulator to the mains or when power supply decay occurs	dE	setting the time from 1 sec. to 999 sec., every 1 sec.	5 (sec.)
display status when the control is switched off	d1	0 – the dot is displayed 1 – the currently measured temperature is displayed	0
return to factory settings	FA	0 – no return to the factory settings 1 – after setting parameter to 1 and turning off the regulator from the power supply, switching it on again restores the factory settings and the parameter value automatically goes back to 0	0
leaving the settings	EE		

**** set at the manufacturing stage (do not change without obvious need)**